

SIGNED DRAWINGS MUST ACCOMPANY PURCHASE ORDER OR DIMENSIONS OF FITTINGS WILL NOT BE GUARANTEED

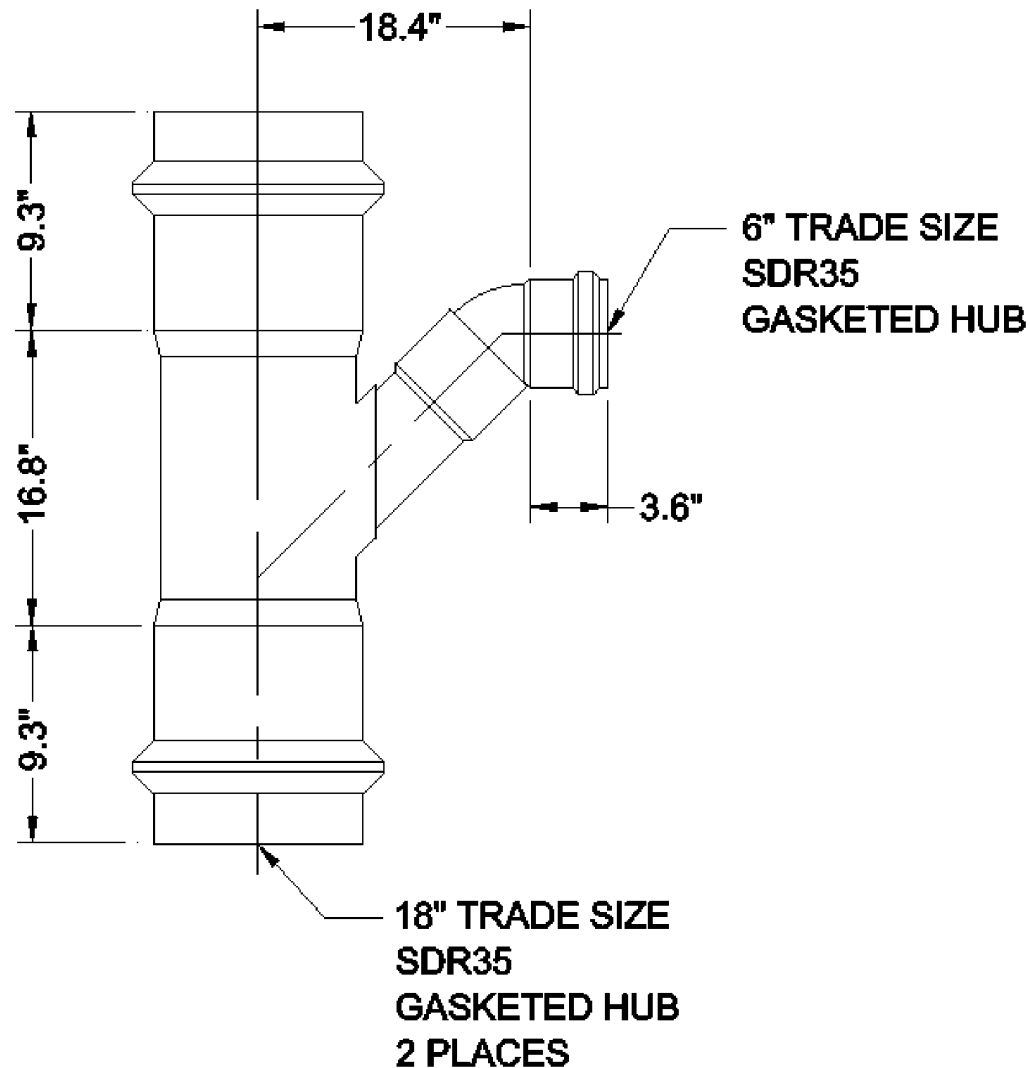

DISCLAIMER - PLEASE READ

- DIMENSIONS AND APPEARANCE ARE APPROXIMATE AND SUBJECT TO CHANGE WITHOUT NOTICE DUE TO DESIGN OR PRODUCTION MODIFICATIONS
- ANGLE TOLERANCE FOR ELBOWS IS +/- 2 DEGREES.
- ALL OTHER DIMENSIONS ARE TO TOLERANCES OF +/- 1"
- ALL FITTINGS ARE SUBJECT TO RBP "STANDARD TERMS AND CONDITIONS"

**18" COMBO WYE & 1/8 BEND
PVC SDR35 GASKETED SEWER
18" x 6" GxGxG**

ROYAL Building Products

royalbuildingproducts.com

56400 Mound Road, Shelby Township, MI 48316
Phone (800)232-5690 -- Fax (586)781-0888

PRINTED COPIES ARE FOR REFERENCE ONLY

DATE: 7/17/2015 DRAWN BY: GEB

DATE: 7/17/2015 CHECKED BY: RBP

L16518-6

CUSTOMER