

Certa-Lok[®], Kwik-Set[®] and Threaded Drop Pipe



KWIK-SET® FEMALE X MALE THREADED PVC DROP PIPE

U.S. Pat No. 6,666,480 7,470,383 7,261,326 7,425,024



SCH 80 (SCH 120 Bell) ASTM D1785 20' Lengths								
Nom. Size	O.D.	Min. Wall Thickness	Bell O.D.	Pipe Weight (lbs./ft.)	Approx. Max. Setting Depth (ft.)	Max. Pressure Rating (psi)	Max. Pump Power (HP)	Part Number
1"	1.315	0.179	1.535	0.42	450	320	1.5	34T01002061000
1 1/4"	1.660	0.191	1.905	0.57	400	260	2.0	34T01252061000
2"	2.375	0.218	2.607	0.96	300	200	7.5	34T02002061000

SCH 120 ASTM D1785 20' Lengths								
Nom. Size	O.D.	Min. Wall Thickness	Bell O.D.	Pipe Weight (lbs./ft.)	Approx. Max. Setting Depth (ft.)	Max. Pressure Rating (psi)	Max. Pump Power (HP)	Part Number
1"	1.315	0.200	1.580	0.46	500	360	1.5	34Q01002061000
1 1/4"	1.660	0.215	1.956	0.64	450	300	2.0	34Q01252061000
2"	2.375	0.250	2.665	1.07	375	240	7.5	34Q02002061000

Installation Instructions for Threaded Drop Pipe and KWIK-SET Pipe:

- Carefully align threads to prevent cross-threading.
- Apply a Teflon®-based plastic compatible thread sealant – do not use Teflon tape.
- Engage joint to hand-tight, and then, using a tool that will not damage the pipe, tighten approximately one turn.
- Overtightening can damage pipe by placing excessive stress in pipe wall.

Notes for Threaded Drop Pipe and KWIK-SET Pipe:

- Dimensions are in inches unless otherwise specified.
- NPT Threading per ASTM F1498.
- All dimensions and weights are subject to normal manufacturing tolerances.
- Pressure ratings are based on ASTM D1785 for threaded pipe at 73°F. Couplings or other fittings used must equal or exceed this value for the drop pipe system to have the rating shown.
- Approximate setting depths shown are based on a set of typical weights and operating parameters (including 60 psi discharge pressure at the well head). Water temperature, type of coupling used, pumping level of water, flow rate, tank pressure, etc., may affect this value. Analysis of project-specific operating conditions should make use of the friction loss chart.
- The well system must include measures to appropriately cool the pump and motor. Elevated temperatures will reduce the maximum setting depth and pressure ratings of the PVC drop pipe.
- All application guidelines are based on the use of a check valve at or within 20' of the pump, and at higher elevations, as required.

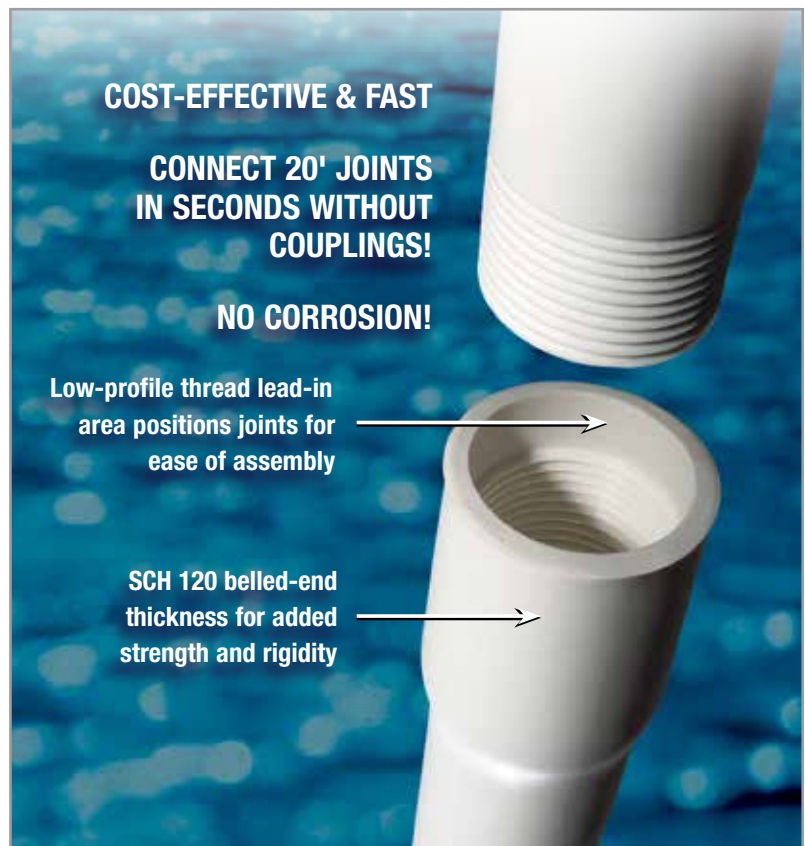

MALE X MALE THREADED PVC DROP PIPE



SCH 80 ASTM D1785 20' Lengths								
Nom. Size	O.D.	Min. Wall Thickness	Pipe Weight (lbs./ft.)	Approx. Max. Setting Depth, (ft.*)	Max. Pressure Rating, (psi)	Max. Pump Power (HP)	Part Number	
							Pipe Only	Pipe w/ Stainless Steel Coupling
1"	1.315	0.179	0.41	550	320	1.5	34T010020A1000	34T010020A10C0
1 1/4"	1.660	0.191	0.57	450	260	2.0	34T012520A1000	34T012520A10C0
2"	2.375	0.218	0.96	300	200	7.5	34T020020A1000	34T020020A10C0

SCH 120 ASTM D1785 20' Lengths								
Nom. Size	O.D.	Min. Wall Thickness	Pipe Weight (lbs./ft.)	Approx. Max. Setting Depth, (ft.*)	Max Pressure Rating, (psi)	Max. Pump Power (HP)	Part Number	
							Pipe Only	Pipe w/ Stainless Steel Coupling
1"	1.315	0.200	0.45	600	360	1.5	34Q010020A1000	34Q010020A10C0
1 1/4"	1.660	0.215	0.63	500	300	2.0	34Q012520A1000	34Q012520A10C0
1 1/2"	1.900	0.225	0.76	450	270	5.0	34Q015020A1000	34Q015020A10C0
2"	2.375	0.250	1.08	375	240	7.5	34Q020020A1000	34Q020020A10C0

* Using stainless steel couplings

Deep Set Threaded Both Ends PVC Drop Pipe 20' Lengths								
Nom. Size	O.D.	Min. Wall Thickness	Pipe Weight (lbs./ft.)	Approx. Max. Setting Depth, (ft.*)	Max Pressure Rating, (psi)	Max. Pump Power (HP)	Part Number	
							Pipe Only	Pipe w/ Stainless Steel Coupling
1"	1.315	0.215	0.46	500	360	1.5	34R010020A1000	34R010020A10C0
1 1/4"	1.660	0.232	0.65	450	300	2.0	34R012520A1000	34R012520A10C0
1 1/2"	1.900	0.240	0.79	450	270	2.5	34R015020A1000	34R015020A10C0
2"	2.375	0.265	1.10	375	240	7.5	34R020020A1000	34R020020A10C0

*Conforms to ASTM D1785

304 Stainless Steel Female Thread NPT x Female Thread NPT Couplings		
Nom. Size	Weight (lbs.)	Part Number
1"	0.68	82157670008
1 1/4"	0.85	82157670015
1 1/2"	1.12	82157670022
2"	1.30	82157670039



MALE X MALE & KWIK-SET THREADED PVC DROP PIPE

Frictional Loss for all Threaded Drop Pipe, ft. – H ₂ O/100 ft.								
Flow Rate GPM	SCH 80				SCH 120			
	1"	1 1/4"	1 1/2"	2"	1"	1 1/4"	1 1/2"	2"
5	2.40	0.59	0.27	0.077	2.99	0.71	0.32	0.091
7	4.48	1.10	0.50	0.14	5.57	1.32	0.59	0.17
10	8.67	2.12	0.97	0.28	10.78	2.56	1.15	0.33
15	18.37	4.50	2.06	0.59	22.85	5.42	2.43	0.70
20	31.29	7.66	3.51	1.01	38.92	9.23	4.14	1.19
25	47.30	11.58	5.31	1.52		13.95	6.26	1.79
30		16.23	7.45	2.14		19.55	8.78	2.51
35		21.59	9.91	2.84		26.01	11.68	3.34
40			12.68	3.64			14.96	4.28
45				4.52			18.60	5.33
50				5.50				6.47
55				6.56				7.72
60				7.71				9.08
Flow Rate (GPM) @ 5 ft/s Recommended Velocity Limit	11	20	27	46	10	19	26	43

KWIK-SET Packaging and Weights						
Nominal Size	Laying Length	Weight (lbs./ft.)	Feet per Lift	Lifts per T/L	Feet per T/L	Weight Per T/L (lbs.)
1"	20'	0.41	2,400'	40	96,000'	38,880
1 1/4"	20'	0.56	2,000'	36	72,000'	40,248
2"	20'	0.94	1,060'	40	42,400'	39,686

Threaded Both Ends Packaging and Weights						
Nominal Size	Laying Length	Weight (lbs./ft.)	Feet per Lift	Lifts per T/L	Feet per T/L	Weight Per T/L (lbs.)
1"	20'	0.43	2,400'	40	96,000'	42,280
1 1/4"	20'	0.60	2,400'	36	72,000'	43,200
1 1/2"	20'	0.56	1800'	40	72,000'	52,560
2"	20'	1.00	1,060'	40	42,400'	43,672

LOCK INTO THE ADVANTAGES OF CERTA-LOK® PVC DROP PIPE

Certa-Lok Non-Threaded, Corrosion-Resistant PVC Drop Pipe

Certa-Lok PVC (Polyvinyl Chloride) Drop Pipe offers an instant, ready-to-use joint utilizing NAPCO's unique, field-proven coupling/spline locking design, which allows submersible pumps to be set or pulled quickly and with confidence.

Certa-Lok PVC Drop Pipe is designed and manufactured to meet or exceed ASTM Specification D1785 requirements (SCH 80). Available in sizes 2" – 8", Certa-Lok PVC Drop Pipe is perfect for a wide range of deep and shallow-well applications, including:

- Domestic wells
- Irrigation wells
- Municipal wells
- Recharge wells
- Test pumps
- Offshore oil platform water supply systems



Certa-Lok PVC Drop Pipe offers you distinct advantages that will boost your bottom line.

Cost effective – Certa-Lok PVC Drop Pipe combines a competitive initial cost with a long life, making it the preferred product for submersible pump installations requiring 2" – 8" drop pipe.

Reliable – The Certa-Lok joint has been successfully used for over 40 years in various water supply applications.

Thread-free – With its groove and spline design, the Certa-Lok joint eliminates the need to constantly rotate the drop pipe for assembly and disassembly.

Easy to handle – 6" Certa-Lok PVC Drop Pipe weighs approx. 112 lbs. per 20' length compared to approx. 400 lbs. for 6" SCH 40 steel.

Easy to set and pull – The Certa-Lok joint is fast and easy to assemble and disassemble by hand. Just insert the pipe into the gasketed coupling, insert the locking spline and tighten the torque control screws.

To disassemble, reverse these steps. For complete assembly instructions, see pages 6 and 10.

Weather resistant – Heat, cold, moisture, humidity and wind do not affect Certa-Lok PVC Drop Pipe joint assembly or disassembly.

Adaptable – Certa-Lok PVC Drop Pipe easily adapts to solvent weld discharge fittings such as Tees, Ells, Flanges, etc. Certa-Lok threaded adapters (PVC or stainless steel) allow easy connection to pumps, check valves and threaded discharge fittings.

Clean – Say goodbye to grease, thread lubricant and pipe dope that can contaminate water supplies.

Lower friction loss – Certa-Lok PVC Drop Pipe provides a Hazen-Williams flow coefficient of 150, vs. 100 for non-corroded metal drop pipe.

Chemical resistant – Certa-Lok PVC Drop Pipe can handle most corrosive fluids, subject to temperature service factors.

NSF listed, customer preferred – PVC compounds used in the manufacturing of Certa-Lok Drop Pipe are NSF 61 listed after being tested for taste, color and toxicity. Many customers prefer to drink potable water pumped through PVC rather than water pumped through metal pipe.

Won't rust or corrode – The inherent properties of PVC prevent it from rusting and corroding like metal drop pipe.

Faster test pumping – Test pump installers can save considerable time and money by using quick, easy-to-assemble and disassemble Certa-Lok joints.

Readily available – Certa-Lok PVC Drop Pipe is available worldwide through your local NAPCO Certa-Lok distributor.



Restrained-Joint PVC Pipe
Efficiency • Performance • Simplicity • Sustainability

ENGINEERING SPECIFICATION

1.0 SCOPE

This specification covers Polyvinyl Chloride (PVC) Drop Pipe for submersible pumps, which utilizes a spline-lock mechanical joining system. Pipe is produced in nominal sizes 2" – 8".

2.0 REFERENCE DOCUMENTS

ASTM International:

ASTM D1784 – Standard Specification for Rigid PVC Compounds and Chlorinated PVC Compounds.

ASTM D1785 – Standard Specification for Poly (Vinyl Chloride) (PVC) Plastic Pipe, Schedules 40, 80, and 120.

ASTM D2837 – Standard Test Method for Obtaining Hydrostatic Design Basis for Thermoplastic Pipe Materials.

NSF International:

NSF 14 – Plastic Piping System Components and Related Materials

NSF 61 – Drinking Water System Components – Health Effects

3.0 REQUIREMENTS

3.1 Materials: Pipe and couplings shall be made from unplasticized PVC compounds having a minimum cell classification of 12454, as defined in ASTM D1784. The compound shall qualify for a Hydrostatic Design Basis (HDB) of 4000 psi for water at 73.4° F, in accordance with the requirements of ASTM D2837. White pipe shall be

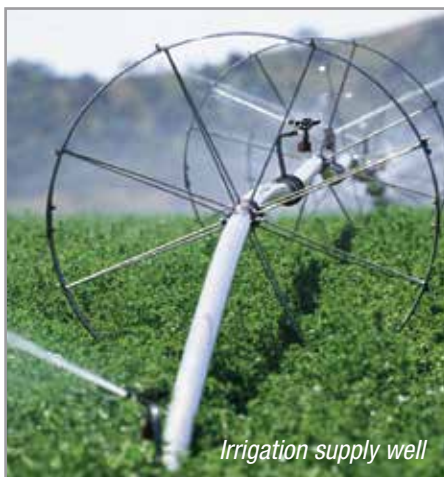

Irrigation supply well

supplied, unless otherwise agreed upon at time of purchase.

3.2 Approvals: PVC products intended for contact with potable water shall be evaluated, tested, and certified for conformance with NSF 61, or the health effects portion of NSF 14, by an acceptable certifying organization, when required by the regulatory authority having jurisdiction.

3.3 Physical Requirements: Standard pipe laying length is 20'. 10' long joints may also be supplied, if available. Nominal drop pipe diameter should be selected by the Design Engineer based on required flow rate, total dynamic head, pump weight, and setting depth/pumping level, utilizing manufacturer-supplied guidelines on allowable tensile loading, pressure, and torque limitations.

3.4 Performance: All pipe supplied to this specification shall meet the performance requirements of ASTM D1785 for SCH 80 pipe.

3.5 Joints: Pipe shall be joined using a spline lock joint. High-strength, acid-resistant, flexible thermoplastic splines shall be inserted into mating precision-machined grooves to provide continuous restraint with evenly distributed loading. No external pipe-to-pipe restraining devices which clamp onto or otherwise damage the pipe surface as a result of point-loading shall be permitted. The joining system shall incorporate elastomeric sealing gaskets which are designed to provide a watertight seal. Note that this specification does not cover pipe with threaded joints.

3.6 Adapters: Drop pipe shall be joined to pumps, check valves, pitless adapters, or other components using a Stainless Steel Drop Pipe Adapter provided by the same manufacturer as provides the drop pipe, and which



Offshore oil platform

utilizes the same spline lock joint as used on the drop pipe.

3.7 Marking: Drop pipe shall be legibly and permanently marked in ink with the following information:

- Manufacturer and Trade Name
- Nominal Size & SCH Rating
- Manufacturing Date Code
- NSF 61

3.8 Workmanship: Pipe and couplings shall be homogeneous throughout and free from visible cracks, holes, foreign inclusions, blisters and dents, interior roughness, and other injurious defects that may affect wall integrity. The pipe and couplings shall be as uniform as commercially practicable in color, opacity, density, and other physical characteristics.

4.0 INSTALLATION

Installation of drop pipe shall be in strict accordance with manufacturer's procedures and recommendations. Prior to installation, drop pipe shall be visually inspected to ensure there is no dirt or foreign matter in the pipe, and any such material which is found shall be removed before installation.

5.0 SUGGESTED SOURCE OF SUPPLY

Certa-Lok PVC Drop Pipe as supplied by:
NAPCO
2801 Post Oak Blvd., Suite 600
Houston, TX 77056
855.624.7473

RAPID JOINT ASSEMBLY

Certa-Lok PVC Drop Pipe is fast and easy to set and pull. You can assemble or disassemble the Certa-Lok joint in seconds – by hand, without any special tools. Since there are no threads, time spent rotating threaded pipe is completely eliminated.

Follow these simple steps for rapid joint assembly:

1. Clean

Clean the joining surfaces and make sure gaskets are clean and evenly seated inside the coupling's gasket grooves. Inspect the gaskets for tears or damage.

2. Lubricate

If lubrication is needed to ease joint assembly, soapy water or NAPCO-approved PVC pipe lubricant can be applied to the joining surfaces prior to assembly. Apply only to the exposed gasket surface and to the tapered end of the drop pipe.

Caution: To maintain joint integrity, do not apply lubricant to the spline or to the spline grooves.

3. Assemble

Insert the drop pipe into the coupling until it seats against the coupling stop. This automatically aligns the locking grooves for receiving the spline. Insert the spline through the entry hole until it is fully seated. This securely locks the joint, while the gasket is designed to provide a reliable, watertight seal. The spline may then be cut so that only a short length protrudes from the coupling to facilitate future disassembly.

In circumstances where there is a need to prevent sand infiltration into the joint (which can make coupling disassembly more difficult), wrap the coupling edges with waterproof tape and seal the spline entry holes with putty or similar material.

4. Tighten torque control screws

The Certa-Lok Drop Pipe system incorporates coupling set-screws, which are tightened to provide resistance against torque imposed on the system by the pump motor during start-up. Set-screws should be tightened after the joint has been assembled and slack removed; manually filling the Certa-Lok Drop Pipe with water before starting the pump will increase hanging weight, helping to remove slack from the joint and air from the system.

Using an allen wrench, tighten the torque control screws into the coupling until each just touches the pipe. By hand, tighten each screw one-half to one full turn or until snug.

Caution: Excessive tightening of the set-screws will cause high local stresses, and may result in a joint that leaks under pressure or a coupling failure. If a stainless steel adapter is used, a small indentation, or countersink, is recommended to provide a recess for the set-screws. This can be accomplished with a conventional power drill, after using the Certa-Lok coupling to mark the set-screw hole locations.



CERTA-LOK DROP PIPE DIMENSIONS & ACCESSORIES

The Certa-Lok system utilizes precision-machined, self-aligning grooves in the pipe and coupling that allow a high-strength flexible spline to be inserted, resulting in a fully circumferential restrained joint that locks the pipe and coupling together.

Flexible elastomeric gaskets (O-rings) in the coupling are designed to provide a reliable watertight pressure seal. Stainless steel torque control screws are used to prevent joint rotation.

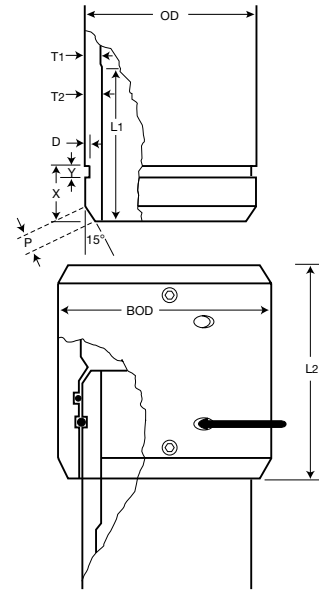

Certa-Lok Drop Pipe											Certa-Lok Coupling				
Size	O.D.	WALL*		L1 Min.	D		X	Y	P	Pipe Weight (lbs./ft.)	Laying Length	Part No.	BOD	L2	Weight (lbs.)
		T1	T2		Min.	Max									
2"	2.375	.218	.262	3.00	.100	.120	1.250	.313	0.250	0.96	20'	34T02002031000	3.200	4.50	0.84
											10'	34T02001031000			
											5'	82157708558			
3"	3.500	.300	.360	3.00	.100	.120	1.313	.375	0.250	1.97	20'	34T03002031000	4.380	4.50	1.27
											10'	34T03001031000			
											5'	82157708589			
4"	4.500	.337	.404	3.50	.125	.145	1.313	.375	0.250	2.87	20'	34T04002031000	5.470	5.00	1.96
											10'	34T04001031000			
											5'	82157708619			
5"	5.563	.375	.450	4.00	.125	.145	1.313	.375	0.250	3.99	20'	34T05002031000	6.625	5.50	2.87
											5'	82157708640			
6"	6.625	.432	.518	4.00	.125	.145	1.313	.375	0.250	5.49	20'	34T06002031000	7.840	6.00	4.24
											10'	34T06001061000			
											5'	82157708671			
8"	8.625	.500	.600	6.00	.135	.155	3.163	.500	0.656	8.35	20'	34T08002031000	10.190	10.00	11.64
											10'	34T08001031000			
											5'	82157708701			

* Minimum wall thickness

Notes

All dimensions are in inches and are subject to normal manufacturing tolerances.

NAPCO also supplies 20' lengths of fully thickened Drop Pipe Nipple Stock, which can be field cut (square cuts are essential) and grooved (a power tool is available) to place the pump at the required setting depth.

20' is the standard length. Consult your distributor or NAPCO for availability of 5' or 10' lengths prior to placing an order.

Packaging and Weights					
Nominal Size	Laying Length	Feet per Lift	Lifts per T/L	Feet per T/L	Weight Per T/L (lbs.)
2"	20'	700	64	44,800	43,366
	10'	350	122	42,700	41,547
3"	20'	920	24	22,080	43,233
	10'	460	46	21,160	41,431
4"	20'	580	26	15,080	42,948
	10'	290	50	14,500	40,890
5"	20'	460	24	11,040	44,028
6"	20'	400	20	8,000	43,456
	10'	200	40	8,000	43,656
8"	20'	280	16	4,480	37,135
	10'	140	32	4,480	37,305

CERTA-LOK DROP PIPE PERFORMANCE DATA

These tables can be used to provide a preliminary assessment for the use of Certa-Lok Drop Pipe in various conditions. To perform a detailed check, please visit the Certa-Lok Drop Pipe Calculator on our website nappcopipe.com.



Notes

- 1.) Maximum hanging weight is the amount allowed at the uppermost Certa-Lok joint.
- 2.) Maximum setting depths showed are based on a set of conservative weight and operating parameters, including a 60 psi discharge pressure at the well head and the maximum recommended flow velocity of 5 ft/s. Water temperature, pumping water level, flow rate, tank pressure, etc., may affect this value.
- 3.) Pressure ratings are based on the use of our stainless steel threaded pump adapter.
- 4.) "Soft-start" controls or variable frequency drives are recommended to minimized imposed torque, especially on motors 50 HP and above.
- 5.) The well system must include measures to appropriately cool the pump and motor. Elevated temperatures will reduce the maximum setting depth and pressure ratings of the PVC drop pipe.

Certa-Lok Drop Pipe Performance Data			
Nominal Size	Approx. Max. Setting Depth (ft.)	Max. Pressure Rating (psi)	Max. Pump/Motor Power (HP)
2"	327	375	20
3"	438	309	30
4"	369	288	50
5"	356	274	75
6"	374	280	100
8"	359	232	125

Certa-Lok Drop Pipe Friction Loss												
Nominal Size	2"		3"		4"		5"		6"		8"	
Flow (GPM)	Velocity (ft/s)	Friction Loss (ft-H ₂ O/100ft)	Velocity (ft/s)	Friction Loss (ft-H ₂ O/100ft)	Velocity (ft/s)	Friction Loss (ft-H ₂ O/100ft)	Velocity (ft/s)	Friction Loss (ft-H ₂ O/100ft)	Velocity (ft/s)	Friction Loss (ft-H ₂ O/100ft)	Velocity (ft/s)	Friction Loss (ft-H ₂ O/100ft)
10	1.09	0.28	0.49	0.04	0.28	0.010	0.18	0.0034	0.12	0.0014	0.07	0.00036
20	2.17	1.01	0.97	0.14	0.56	0.037	0.35	0.012	0.25	0.0051	0.14	0.0013
30	3.26	2.13	1.46	0.30	0.84	0.078	0.53	0.026	0.37	0.011	0.21	0.0027
40	4.35	3.62	1.94	0.51	1.12	0.13	0.71	0.044	0.49	0.018	0.28	0.0047
50	5.43	5.48	2.43	0.77	1.40	0.20	0.88	0.066	0.62	0.028	0.35	0.0071
60	6.52	7.67	2.91	1.08	1.67	0.28	1.06	0.092	0.74	0.039	0.42	0.010
70	7.61	10.20	3.40	1.44	1.95	0.38	1.23	0.12	0.86	0.051	0.49	0.013
80	8.69	13.06	3.89	1.85	2.23	0.48	1.41	0.16	0.98	0.066	0.56	0.017
90	9.78	16.24	4.37	2.30	2.51	0.60	1.59	0.20	1.11	0.082	0.63	0.021
100			4.86	2.79	2.79	0.73	1.76	0.24	1.23	0.10	0.70	0.025
150			7.29	5.91	4.19	1.54	2.65	0.50	1.85	0.21	1.05	0.054
200			9.71	10.06	5.58	2.62	3.53	0.86	2.46	0.36	1.41	0.09
250					6.98	3.95	4.41	1.30	3.08	0.54	1.76	0.14
300					8.37	5.54	5.29	1.82	3.69	0.76	2.11	0.19
350					9.77	7.37	6.17	2.41	4.31	1.01	2.46	0.26
400							7.05	3.09	4.92	1.29	2.81	0.33
450							7.94	3.84	5.54	1.60	3.16	0.41
500							8.82	4.67	6.15	1.95	3.51	0.50
550							9.70	5.57	6.77	2.33	3.86	0.60
600									7.38	2.73	4.22	0.70
700									8.62	3.63	4.92	0.93
800									9.85	4.65	5.62	1.19
900											6.32	1.48
1000											7.03	1.80
1100											7.73	2.15
1200											8.43	2.52
1300											9.13	2.92
1400											9.84	3.35
Flow Rate (GPM) @ 5 ft/s Recommended Velocity Limit	46.0		102.9		179.2		283.5		406.2		711.6	

CERTA-LOK

CERTA-LOK DROP PIPE COUPLING

CERTA-LOK FEMALE X CERTA-LOK FEMALE
INCLUDES GASKETS, SPLINES & SCREWS

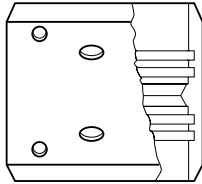

Size	Part Number
2"	82157707209
3"	82157707216
4"	82157707223
5"	82157707230
6"	82157707247
8"	82157707254

CERTA-LOK DROP PIPE ADAPTER COUPLING

CERTA-LOK FEMALE x SOLVENT WELD SOCKET
INCLUDES GASKET, SPLINE & SCREWS

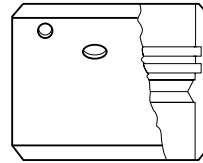

Size	Part Number
2"	82157708114
3"	82157708121
4"	82157708138
5"	82157708145
6"	82157708152
8"	82157708169

CERTA-LOK PVC DROP PIPE ADAPTER*

CERTA-LOK MALE X MALE THREAD NPT

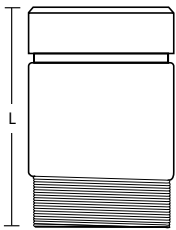

Size	Part Number	L
2"	82157707513	6.00
3"	82157707520	6.25
4"	82157707537	7.00
5"	82157707544	7.25
6"	82157707551	7.50
8"	82157707568	8.00

CERTA-LOK 316 STAINLESS STEEL DROP PIPE ADAPTER

CERTA-LOK MALE x MALE THREAD NPT

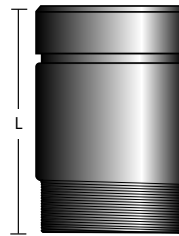

Size	Part Number	L
2"	82157010530	6.00
3"	82157010531	6.00
4"	82157010532	6.00
5"	82157010533	6.00
6"	82157010534	6.00
8"	82157010535	9.00

* These items are not recommended for pump-to-pipe connections.

CERTA-LOK PVC DROP PIPE NIPPLE

CERTA-LOK MALE X PLAIN END

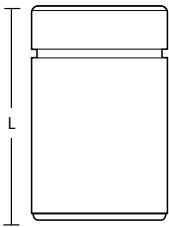

Size	Part Number	L
2"	82157707414	6.00
3"	82157707421	6.25
4"	82157707438	7.00
5"	82157707445	7.25
6"	82157707452	7.50
8"	82157707469	8.00

CERTA-LOK DROP PIPE TORQUE CONTROL SCREWS

316 STAINLESS STEEL

Sizes	Coupling Sizes	Part Number
3/8" x 3/8" L	2" - 3"	82157549519
3/8" x 1/2" L	4" - 8"	82157549526



SPLINE					O-RING (Teflon® Coated)		
Size	Part Number	Size (In.)	Length (In.)	Material	Size	Part Number	Material
2"	S0210RV0	.188 RND.	10.5	PVDF	2"	OR020YMNN	Nitrile
3"	S0316RV0	.25 RND.	16	PVDF	3"	OR030YMNN	Nitrile
4"	S0418RV0	.25 RND.	18	PVDF	4"	OR040YMNN	Nitrile
5"	S0520RV0	.25 RND.	20	PVDF	5"	OR050IBON	Nitrile
6"	S0624RV0	.25 RND.	24	PVDF	6"	OR060IBON	Nitrile
8"	S0832SV0	.313 SQ.	32	PVDF	8"	OR080YMNI	Nitrile

CERTA-LOK DROP PIPE APPLICATION AND INSTALLATION GUIDELINES

Certa-Lok Drop Pipe for submersible pumps is engineered and manufactured to provide long and reliable service in most well applications. For best results, the following guidelines must be observed when installing Certa-Lok Drop Pipe.

The NAPCO website provides an online Certa-Lok Drop Pipe Calculator which must be consulted to determine the appropriate size pipe for the proposed application. Select a size carefully to accommodate the maximum anticipated flow rate, and always account for worst-case transient conditions (e.g., surge pressures, increased pressure at start-up, etc.). The discharge pressure used must account for the effect of any upstream piping, including changes of elevation. Maximum flow velocity of 10 fps is recommended to control transient surge pressures; lower velocities are preferred.

Handle pipe and couplings with normal care at all times, being particularly careful not to strike the pipe with any objects, especially in colder weather. When unloading the truck, lower pipe slowly to the ground.

Important: Do not use Certa-Lok Drop Pipe if there is the potential for pump-generated heat, which can occur if the system is allowed to operate continuously under zero flow/pump shut-off head conditions. Heat can greatly reduce the strength of thermoplastic materials. A safety cable or rope must be used on all installations due to this potential problem.

All Certa-Lok Drop Pipe application guidelines are given with the assumption that a check-valve is used at or within 20 feet of the pump and at higher elevations, as required, to control water hammer.

If surge pressures are not totally predictable due to potential variations in system operation, a properly sized pressure relief valve must be installed at the well-head. Consult the tables on page 9 to verify that maximum system pressures, which develop when the relief valve actuates, do not exceed published pressure ratings.



Note: As NAPCO cannot predict the degree of pump motion that may be experienced in a particular application due to factors such as mechanical unbalance, a centralizer or torque arrestor located directly above the pump should be considered, especially on deeper wells, to prevent the Certa-Lok Drop Pipe from whipping and vibrating. Use and spacing of additional centralizers above the pump should be determined based on the particular installation conditions.

“Soft-start” controls are recommended to minimize imposed torque, especially on the higher HP motors (50 HP and above).



IDEAL FOR USE IN A WIDE RANGE OF DEEP & SHALLOW-WELL APPLICATIONS

NAPCO Drop Pipe is available to suit all of your needs:



Threaded Both Ends Drop Pipe –
Threaded both ends provides the flexibility of using stainless steel or PVC couplings depending on your application.



KWIK-SET Drop Pipe – No need for additional couplings, our KWIK-SET has a threaded bell end for faster installation.



Certa-Lok Drop Pipe – The best locking mechanical joint in the industry. Utilizes our spline lock joining system, with additional torque screws for preventing pipe rotation.



1.855.624.7473 | napcopipe.com

NAPCO
2801 Post Oak Blvd., Suite 600
Houston, TX 77056