

8" TRADE SIZE
SDR35 GASKETED
SEWER HUB

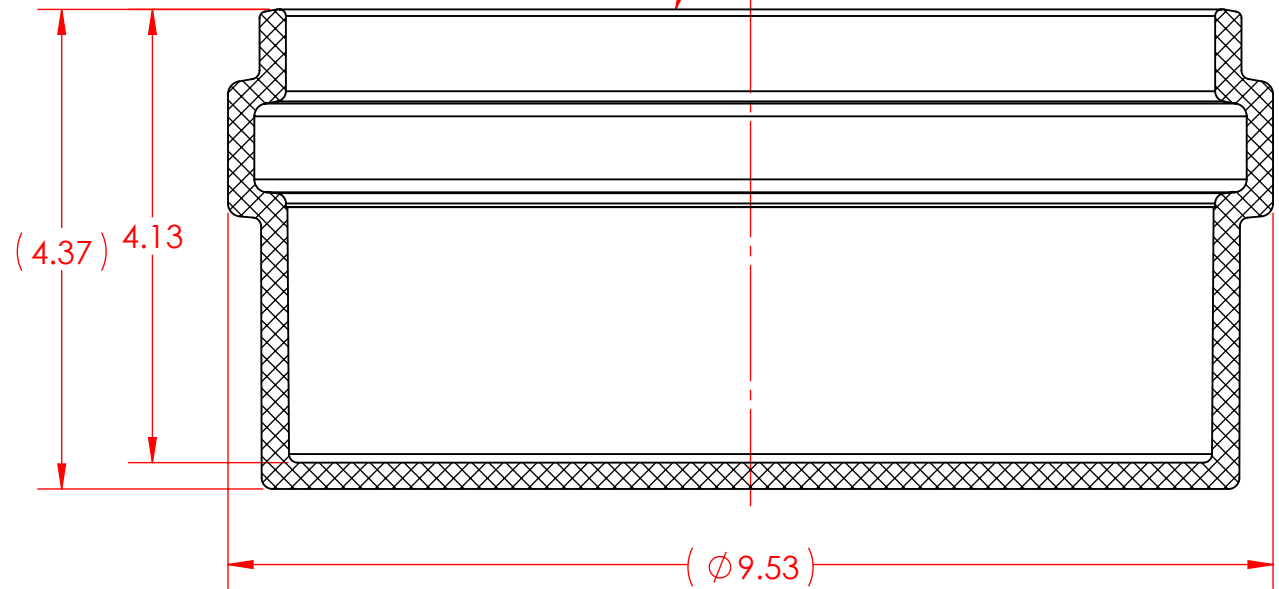

REF. ASTM D3034
CSA B182.1, 182.2

NAPCO PIPE & FITTINGS

56400 Mound Road
Shelby Township, MI 48316
U.S.A.
Phone (800) 232-5690 | Fax (586) 781-0888
CSshelby@napcopipe.com | www.napcopipe.com

Part Number	Product Line	Color
G1608	SDR35 US	White
40CAP08G	SDR35 CAN	White

NOTE: GASKETS NOT SHOWN

8" CAP (G)
PVC SDR35 GASKETED SEWER
8" (G)

REFERENCE ONLY

FILE NAME:

G1608.D01